



REFERENCE

200/300/500

Power Amplifiers

OWNERS MANUAL
AND
INSTALLATION GUIDE

SOUNDSTREAM[®]
TECHNOLOGIES

REFERENCE Amplifier (REFERENCE500 shown)

Handcrafted in the U.S.A.

Fault ●
High Power ●
High Current ●



+12v GND REMOTE



+ L - R -



LSE G

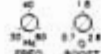

LEVEL



L R



MONO / STEREO / MIXED MONO



HIGH CURRENT / HIGH POWER

DESIGN FEATURES

- **Uncompromising Design and Construction** including mil-spec glass epoxy circuit boards and high current custom gold-plated solid brass connections that will accept up to 4 gauge power/ground wire (8 gauge on the REF200).
- **High Power/High Current Capability** - Soundstream's exclusive circuit which permits customization of your amplifier to its particular application—high current, low impedance loads (multiple subwoofers, less than 2 ohms mono) or High Power, higher impedance loads (2 ohms mono and up).
- **Coherent Stereo™/Mixed Mono** selection for either "pure" stereo operation or mixed mono for simultaneous stereo and mono.
- **Chassisink™ Darlington Power Array** - Soundstream's "overbuilding" of the output section incorporates multiple output transistors instead of a few for faster, stronger power delivery. The transistors are sandwiched between the circuit board and the heatsink in a design called Chassisink™ to ensure cool, efficient amplifier operation.

- **PowerGrid Power Supply Design** - All power supply components are located near one another, connected by thick, wide PCB traces, which ensures rapid, high current delivery. The entire power supply is isolated on one side of the circuit board while the audio stage is located opposite it, guaranteeing minimal noise.
- **Ultra-Low ESR Capacitance Bank** - Multiple small input power capacitors are used to provide a lower ESR (Equivalent Series Resistance), which *means more power in and out faster*.
- **Smart Thermal Rollback** - Most amplifiers shut off when they get too hot. In the unlikely event the REFERENCE amplifier reaches 85° C, it will gradually roll back its average power (without affecting the dynamics). Once the amplifier has cooled off, it returns to full power output. If overheating should continue, a second thermal sensing protection circuit will shut off the amplifier if the heatsink reaches 95° C.
- **Unregulated Power Supply** - 4 ohm power ratings are measured at 12 volts, meaning substantially greater output in the real world when the vehicle is running, where voltages range from 13.2 to 14.4 volts.
- **Fault Monitor LED** on the front panel notifies you of blown power supply fuses.
- **1/2 ohm Drive Ability** - The REFERENCE amplifiers are designed to drive virtually any load—all the way down to 1/2 ohm stereo (1 ohm mono).
- **Dual Discrete Class A Drive Stages** - Over six times the drive current of most amps, which maintains performance into low impedance loads.
- **Drive Delay™ Muted Turn-on/off Circuit** - A unique circuit which completely eliminates any amplifier-related turn-on/off noises.
- **Flexible Input Sensitivity** accepts voltages from 100 mV to 2.5 V, permitting maximum output from the amplifier with virtually any source unit.
- **Balanced Input Design** for added immunity to noise caused by component and vehicle electrical system interaction.
- **LSE.Q (REFERENCE500)** fully adjustable subwoofer equalization circuit providing frequency and leve/"Q" adjustment for optimum subwoofer performance. An adjustable subsonic filter protects woofers from damaging low frequency information and maximizes output in a usable range.

REFERENCE POWER SUPPLY DESIGN

The REFERENCE amplifiers employ an extremely efficient unregulated pulse-width modulated power supply. REFERENCE amplifiers from Soundstream are rated at 12 volts but are designed to take advantage of the additional voltage available when the vehicle is running. The two major advantages of the unregulated power supply are:

- awesome dynamic power capabilities
- added continuous power with higher voltages (see chart below)

Because of the dynamic properties of most music, all audio components should be able to react accordingly. Thanks to their unregulated power supplies, the REFERENCE amplifiers can comfortably exceed their rated power for dynamic portions of the music.

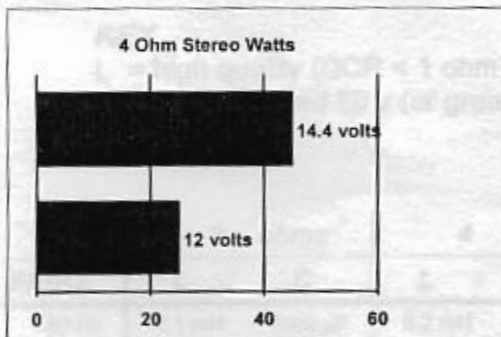

4 ohm Power

25 watts x 2 @ 12 volts
45 watts x 2 @ 14.4 volts
(REFERENCE200 shown)

PASSIVE AND ELECTRONIC CROSSOVERS

Your REFERENCE amplifier is unique in its ability to switch between Coherent Stereo™ and mixed mono output mode. The REFERENCE amplifiers are capable of driving a complete subwoofer and satellite system in the Mixed Mono configuration. However, for lowest distortion, maximum output, and best sound quality, we recommend that you use an electronic crossover and multiple channels of amplification.

If a single REFERENCE amplifier is to drive a subwoofer and satellite system, passive high and low pass crossovers will be necessary. Use the charts on pages 7 & 8 to determine the values of the crossover components.



6 dB/OCTAVE PASSIVE CROSSOVER CHART

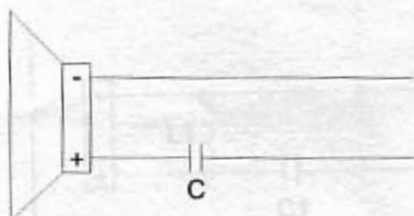

6 dB/octave high pass

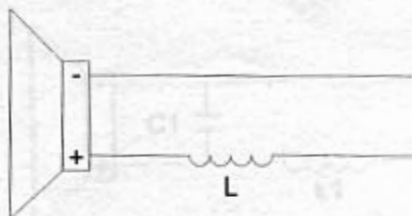

6 dB/octave low pass

KEY

L = high quality (DCR < 1 ohm) inductor/coil

C = non-polarized 50 v (or greater) capacitor

FREQ.	2 ohms		4 ohms		8 ohms	
	L	C	L	C	L	C
80 Hz	4.1 mH	1000 μ F	8.2 mH	500 μ F	16 mH	250 μ F
100 Hz	3.1 mH	800 μ F	6.2 mH	400 μ F	12 mH	200 μ F
130 Hz	2.4 mH	600 μ F	4.7 mH	300 μ F	10 mH	150 μ F
200 Hz	1.6 mH	400 μ F	3.3 mH	200 μ F	6.8 mH	100 μ F
260 Hz	1.2 mH	300 μ F	2.4 mH	150 μ F	4.7 mH	75 μ F
400 Hz	0.8 mH	200 μ F	1.6 mH	100 μ F	3.3 mH	50 μ F
600 Hz	0.5 mH	136 μ F	1.0 mH	68 μ F	2.0 mH	33 μ F
800 Hz	0.41 mH	100 μ F	0.82 mH	50 μ F	1.6 mH	26 μ F
1000 Hz	0.31 mH	78 μ F	0.62 mH	39 μ F	1.2 mH	20 μ F
1200 Hz	0.25 mH	66 μ F	0.51 mH	33 μ F	1.0 mH	16 μ F
1800 Hz	0.16 mH	44 μ F	0.33 mH	22 μ F	0.68 mH	10 μ F
4000 Hz	0.08 mH	20 μ F	0.16 mH	10 μ F	0.33 mH	5 μ F

12 dB/OCTAVE PASSIVE CROSSOVER CHART

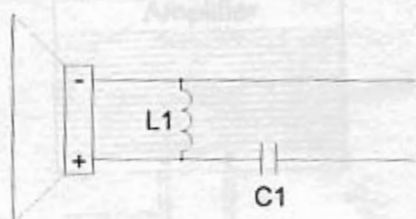

12 dB/octave high pass

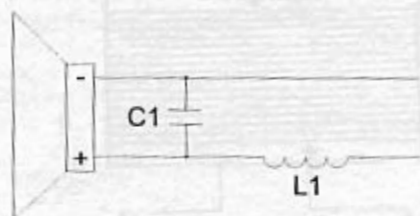

12 dB/octave low pass

KEY

L1 = high quality (DCR < 1 ohm) inductor/coil

C1 = non-polarized 50 v (or greater) capacitor

FREQ.	2 ohms		4 ohms		8 ohms	
	L1	C1	L1	C1	L1	C1
80 Hz	5.5 mH	680 μ F	11 mH	330 μ F	22 mH	180 μ F
100 Hz	4.7 mH	560 μ F	9.1 mH	270 μ F	18 mH	150 μ F
130 Hz	3.3 mH	400 μ F	6.8 mH	200 μ F	15 mH	100 μ F
200 Hz	2.2 mH	300 μ F	4.7 mH	150 μ F	9.1 mH	75 μ F
260 Hz	1.8 mH	200 μ F	3.6 mH	100 μ F	6.8 mH	50 μ F
400 Hz	1.1 mH	150 μ F	2.2 mH	68 μ F	4.7 mH	33 μ F
600 Hz	0.75 mH	100 μ F	1.5 mH	47 μ F	3.0 mH	26 μ F
800 Hz	0.5 mH	68 μ F	1.0 mH	33 μ F	2.0 mH	15 μ F
1000 Hz	0.47 mH	50 μ F	0.9 mH	27 μ F	1.8 mH	13 μ F
1200 Hz	0.33 mH	44 μ F	0.75 mH	22 μ F	1.5 mH	11 μ F
1800 Hz	0.27 mH	30 μ F	0.50 mH	15 μ F	1.0 mH	6.8 μ F
4000 Hz	0.10 mH	15 μ F	0.22 mH	6.8 μ F	0.47 mH	3.3 μ F

SERIES AND PARALLEL WIRING

Below are examples of series and parallel wiring configurations. Please note how the impedances differ with the different configurations.

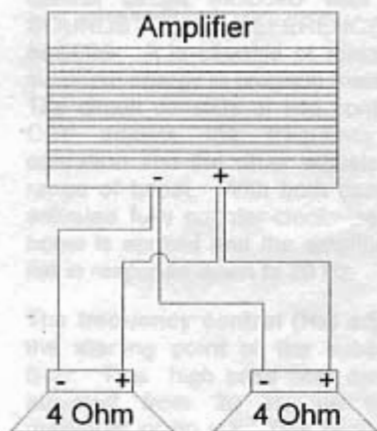

**2-4 ohm drivers in parallel
= 2 ohms**

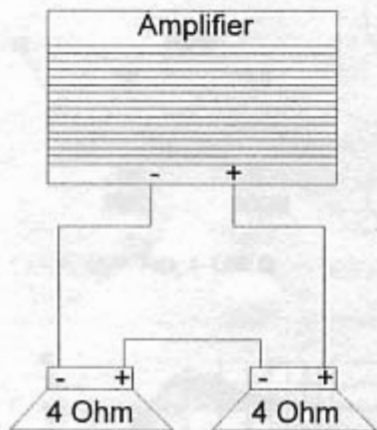

**2-4 ohm drivers in series
= 8 ohms**

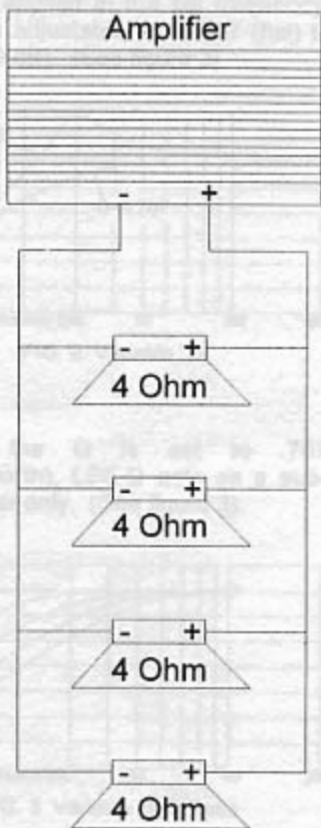

**4-4 ohm drivers in parallel
= 1 ohm**

LSE.Q THEORY AND USE

LSE.Q is a unique subwoofer control circuit included with the SOUNDSTREAM REFERENCE500 amplifier. It is capable of removing subsonic energy in program material. The circuit consists of two controls. One adjusts the frequency of operation and the other adjusts the range of boost. With both controls adjusted fully counter-clockwise, no boost is applied and the amplifier is flat in response down to 20 Hz.

The **frequency control (Hz)** adjusts the starting point of the subsonic filter. This high pass filter can be adjusted from 20 Hz up to a maximum of 60 Hz. This control is useful for setting the lowest frequency that your subwoofer will see. (See figure 1)

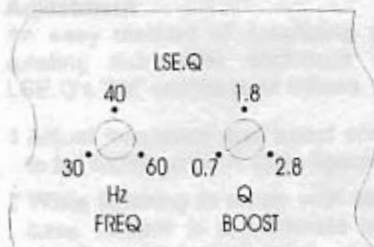

FIG. 1 LSE.Q

The **Q control** adjusts the amount of boost applied at the set frequency. This is adjustable from .707 (flat) to 2.8 (+9 dB). (See figure 2)

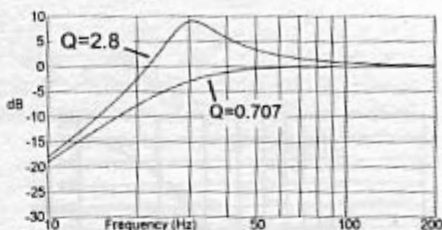

FIG. 2 Variable "Q"

When the Q is set to .707 (Butterworth), LSE.Q acts as a subsonic filter only. (See figure 3)

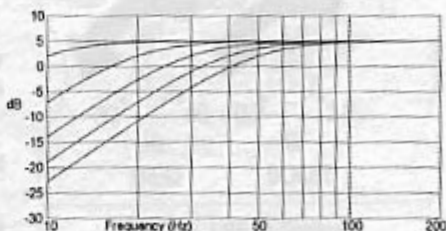

FIG. 3 Variable High Pass

The simple act of removing the signal below the vented tuning frequency can improve system output by as much as 3 dB. With Q values greater than .707, boost is added in addition to the sub-sonic filter. (see figure 4)

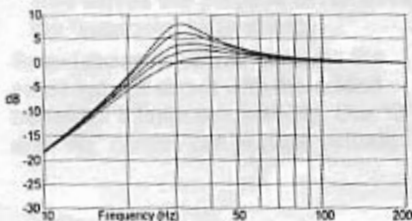

FIG. 4 Variable "Q"

LSE.Q THEORY AND USE (continued)

Application

Woofers in vented enclosures have good power handling characteristics above the tuning frequency, but below the tuning frequency, power handling drops off considerably. This is due to the loss of any appreciable resistive air mass. At frequencies below resonance, the woofer starts to behave as if it were mounted in "free-air". If we wish to improve the performance of a vented system, we should remove these unwanted signals from our system. These can be removed by adding a subsonic filter. Figure 5 shows the effectiveness of LSE.Q on woofer excursion. Woofer travel is 7.5 mm at 10 Hz, with LSE.Q properly adjusted, this excursion can be reduced to less than 1 mm. This is of great benefit to lowering woofer distortion and increasing output.

Adjustment

An easy method of optimizing your existing subwoofer enclosure with LSE.Q's "Hz" control is as follows.

- 1 Adjust frequency and boost control to full CCW position. (See figure 6)
- 2 While listening to music with strong bass content at a moderate level, slowly adjust frequency control clockwise. Listen for a reduction of bass response. Now, rotate frequency control slightly backwards. This serves the purpose of removing the "subsonic" bass energy.

Soundstream's LSE.Q contains the same type of circuit with the added benefit of infinite adjustability. Our "Q" and "Hz" control can provide virtually

any combination of boost and cut to suit your designs. So, LSE.Q can provide the "tailoring" needed for any type of "assisted" design and any woofer.

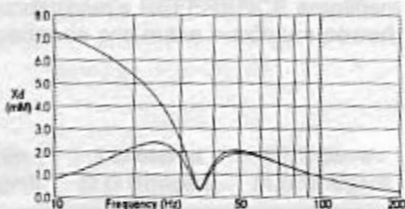

FIG. 5 Limited Excursion

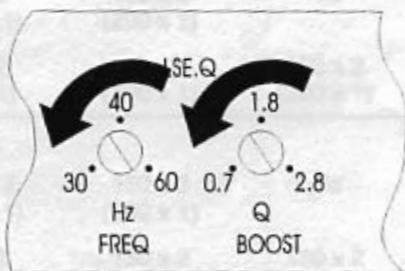

FIG. 6 LSE.Q Setting

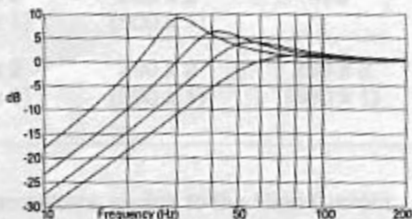

FIG. 7 Various Settings

INSTALLATION STEP 1

SETTING THE HIGH POWER/HIGH CURRENT SWITCH

The High Power/High Current switch allows the REFERENCE amplifier to be one of two types of amps: either producing maximum power at higher impedances (perfect for satellites) or at lower impedances (usually with multiple subwoofers).

The circuit operates by selecting a set of power supply voltage rails best suited to your particular application. One is a higher voltage "tap" optimized for high impedance applications while the other is lower voltage designed to provide more current. Unlike other amplifiers, Soundstream's REFERENCE amplifiers can be configured to drive virtually any impedance *and* make maximum power!

POWER	4 Ω Stereo (8 Ω Bridged)	2 Ω Stereo (4 Ω Bridged)	1 Ω Stereo (2 Ω Bridged)	1/2 Ω Stereo (1 Ω Bridged)
	<i>REFERENCE 200</i>			
High Power Watts	25 x 2 (50 x 1)	50 x 2 (100 x 1)	100 x 2 (200 x 1)	n/a
High Current Watts	12.5 x 2 (25 x 1)	25 x 2 (50 x 1)	50 x 2 (100 x 1)	100 x 2 (200 x 1)
	<i>REFERENCE 300</i>			
High Power Watts	75 x 2 (150 x 1)	150 x 2 (300 x 1)	150 x 2 (300 x 1)	n/a
High Current Watts	37.5 x 2 (75 x 1)	75 x 2 (150 x 1)	150 x 2 (300 x 1)	150 x 2 (300 x 1)
	<i>REFERENCE 500</i>			
High Power Watts	125 x 2 (250 x 1)	250 x 2 (500 x 1)	250 x 2 (500 x 1)	n/a
High Current Watts	62.5 x 2 (125 x 1)	125 x 2 (250 x 1)	250 x 2 (500 x 1)	250 x 2 (500 x 1)

OTHER COMMENTS:

If you blow fuses with the REFERENCE amplifiers, switch to the High Current mode. If the problem persists, it is likely that the amplifier is seeing a dead short, either in the speaker wire or in the speaker itself. ***Rectify the problem before blowing multiple fuses!***

INSTALLATION STEP 2

COHERENT STEREO™/MIXED-MONO MONO/BRIDGED MONO

The REFERENCE amplifiers have the ability to operate in any one of the following modes:

Coherent Stereo™ with identical left and right stereo channels for maximum fidelity. Best choice for satellite speakers. Use this mode unless Mixed-Mono is necessary.

Mixed-Mono in order to drive stereo and mono simultaneously; works well for center channels. It can be used anytime you need a summed mono channel. Somewhat sacrifices sonic accuracy as additional circuitry is introduced to one channel. *In Mixed-Mono, the left channel is inverted, see diagram below or on the bottom of the amplifier.*

Bridged Mono for dedicated single channel operation; ideal for driving subwoofers. It is also used when large amounts of power are necessary for single speakers. *In bridged mono, only the right channel input is active.*

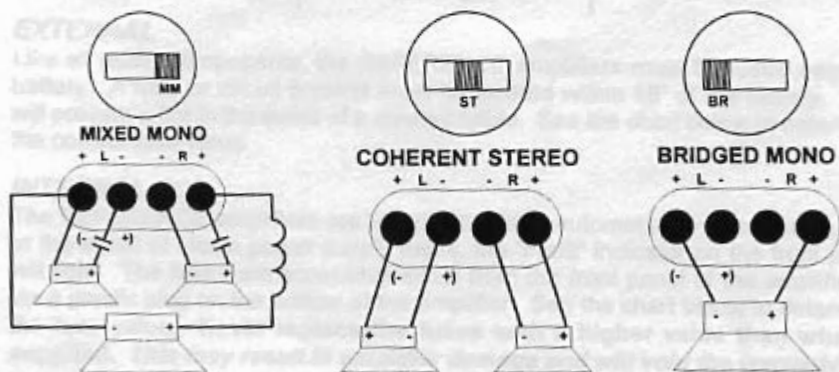

In bridged mono, only the right channel input is active.

NOTE: If you intend to drive a REFERENCE amp in Mono but have stereo outputs from your crossover or source unit, you can put the switch in Mixed-Mono but follow the normal wiring for Bridged Mono.

INSTALLATION STEP 3

WIRING

POWER AND GROUND

To ensure maximum output from your REFERENCE amplifier, use high quality, low-loss power and ground cables. The REFERENCE amplifiers will accept up to 4 gauge power and ground cables (8 ga. with REFERENCE200). Determine from the chart below the minimum gauge power and ground wire for your application.

CIRCUIT BREAKERS/FUSES

	<i>up to 10'</i>	<i>up to 20'</i>
REFERENCE200	Soundstream Power80 or Power100 (8 or 10 ga.)	Soundstream Power80 (8 ga.)
REFERENCE300	Soundstream Power40 or Power 80 (4 or 8 ga.)	Soundstream Power40 (4 ga.)
REFERENCE500	Soundstream Power40 or Power 80 (4 or 8 ga.)	Soundstream Power40 (4 ga.)

EXTERNAL

Like all audio components, the REFERENCE amplifiers must be fused near the battery. A fuse or circuit breaker must be located within 18" of the battery. This will prevent a fire in the event of a shorted cable. See the chart below to determine the correct fuse value.

INTERNAL

The REFERENCE amplifiers are fused with either automotive-type or Maxi-fuses. In the event of blown power supply fuses, the "Fault" indicator on the front panel will light. The fuses are accessible either from the front panel of the amplifier or via a plastic plug on the bottom of the amplifier. See the chart below to determine the fuse value. **Never replace the fuses with a higher value than what is supplied. This may result in amplifier damage and will void the warranty!**

REFERENCE Amplifier Fuse Values

<i>Amplifier</i>	<i>Amplifier Fuse</i>	<i>Battery Fuse</i>
REFERENCE200	20 amp automotive	30 amp
REFERENCE300	30 amp automotive	40 amp
REFERENCE500	40 amp MAXI-fuse	50 amp

WIRING (cont.)

REMOTE TURN-ON

Connect the "Remote" to the turn-on lead from the source unit. When +12 volts is received, the amplifier will turn on.

SIGNAL CABLE

Use a high-quality cable that will be easy to install and has minimal signal loss to guarantee optimum performance. Soundstream's DL-1 and SL-1 are ideal.

SPEAKER CABLE

The REFERENCE amps will accept up to 8 gauge speaker cable. Use a high quality, flexible, multi-strand cable for best performance and longevity. Soundstream Speaker120 & 160 (12 and 16 gauge) are ideal.

WIRING DIAGRAM

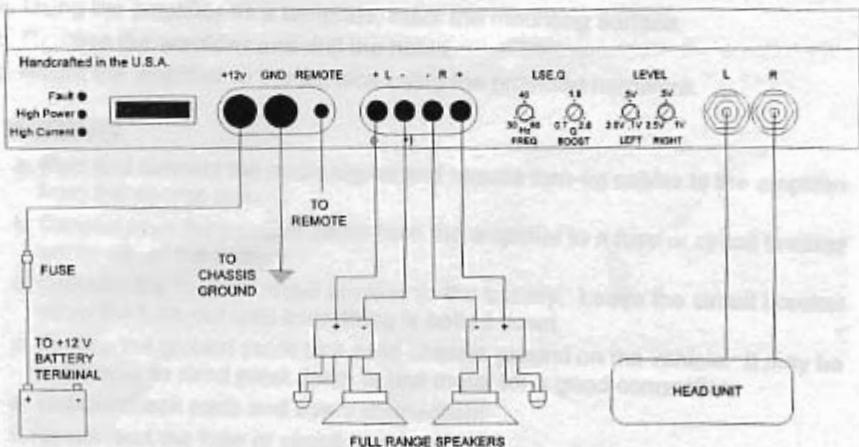

INSTALLATION STEP 4

INSTALLATION AND MOUNTING

1. **AMPLIFIER LOCATION**

The REFERENCE amplifiers employ highly efficient circuitry and a unique Chassisink™ design to maintain lower operating temperatures. Additional cooling may be required if the amplifier is located in a tightly confined area or when driving especially low impedance loads at extremely high levels.

When mounting the amplifier, it should be securely mounted to either a panel in the vehicle or an amp board or rack that is securely mounted to the vehicle. The mounting location should be either in the passenger compartment or in the trunk of the vehicle, away from moisture, stray or moving objects, and major electrical components. To provide adequate ventilation, mount the amplifier so that there are at least two inches of freely circulating air above and to the sides of it.

2. **SWITCHES**

Set High Power/High Current and Coherent Stereo™/Mixed-Mono/Bridged Mono switches to the appropriate positions (see pages 12 - 13).

3. **MOUNTING THE AMPLIFIER**

- Using the amplifier as a template, mark the mounting surface.
- Remove the amplifier and drill the holes.
- Mount the amplifier to the surface using the provided hardware.

4. **WIRING**

- Run and connect the audio signal and remote turn-on cables to the amplifier from the source unit.
- Carefully run the positive cable from the amplifier to a fuse or circuit breaker within 18" of the battery.
- Connect the fuse or circuit breaker to the battery. Leave the circuit breaker off or the fuse out until everything is bolted down.
- Secure the ground cable to a solid chassis ground on the vehicle. It may be necessary to sand paint down to raw metal for a good connection.
- Double check each and every connection!
- Re-connect the fuse or circuit breaker.

5. **POWER UP**

Power up the system and look at the green and red LEDs; depending on the configuration, one should be lit. There may be a 2 -3 second delay from the time the source unit is turned on to the time that the LED on the amp turns on, which is normal. Once the amplifier power LED is on and the source unit is playing, you should have sound coming from the speakers.

INSTALLATION STEP 5

LEVEL SETTING

The input levels are adjusted by means of the input level controls located on the front of the amplifier. This is a unique dual-stage circuit that adjusts both level and gain. This topology maintains better Signal to Noise ratios even when using sources with minimal output.

In the ideal situation, all components in the audio system reach maximum undistorted output at the same time. The reason is because an amplifier will only make what comes into it bigger. So, if you send it a distorted signal from the head unit, the amplifier is going to amplify distorted information. The same thing holds true if an outboard processor or crossover begins to distort before you have maximum output from the amplifier. By setting all components to reach clipping at the same time, you can maximize the output of your system. For the REFERENCE amplifiers, follow the below procedure for the quickest, easiest means of setting the levels.

1. Turn the amp's input levels to minimum position (fully counter-clockwise).
2. Set source unit volume to approximately 3/4 of full volume.
3. While playing dynamic source material, slowly increase the amplifier's input level until a near maximum undistorted level is heard in the system.

NOTE: Even though the S/N ratio with low output sources is better with the REFERENCE amplifiers than others, your best combination of output level and Signal to Noise ratio will be achieved when the input levels are set between 500 mV and 2.5 V.

PROTECTION CIRCUITRY

Your REFERENCE amplifier is protected against both overheating and short circuits by means of the following circuits:

- Main power supply fuses
- Smart Power Supply Thermal Rollback activating at 85°C.
- A fail-safe thermal protection circuit activating at 95°C.

Your amplifier also incorporates an innovative Fault Diagnosis system that identifies a blown power supply fuse.

NOTE: *If you experience blown main power supply fuses, DO NOT increase values beyond the original fuse value! Doing so will void your warranty and may damage your amplifier.*

TROUBLESHOOTING

PROBLEM	CAUSE
No sound and LEDs are not lit	<ul style="list-style-type: none">• no power or ground at amp• no remote turn-on signal• blown fuse near battery
Fault LED is lit	<ul style="list-style-type: none">• amp power supply fuse is blown or missing
Repeatedly blown amp fuse, frequent activation of Smart Power Supply Circuit	<ul style="list-style-type: none">• check speaker configuration, amp may be in "High Power" mode, put amp into "High Current" mode if speaker load is less than 2 ohms (see p.12, "Setting High Power/High Current Switch")• speaker or leads may be shorted• verify adequate amplifier ventilation

SERVICE

Your Soundstream REFERENCE amplifier is protected by a limited warranty. Please read the enclosed warranty card.

SPECIFICATIONS

POWER	4 Ω Stereo (8 Ω Bridged)	2 Ω Stereo (4 Ω Bridged)	1 Ω Stereo (2 Ω Bridged)	1/2 Ω Stereo (1 Ω Bridged)
	<i>REFERENCE 200</i>			
High Power Watts	25 x 2 (50 x 1)	50 x 2 (100 x 1)	100 x 2 (200 x 1)	n/a
High Current Watts	12.5 x 2 (25 x 1)	25 x 2 (50 x 1)	50 x 2 (100 x 1)	100 x 2 (200 x 1)
	<i>REFERENCE 300</i>			
High Power Watts	75 x 2 (150 x 1)	150 x 2 (300 x 1)	150 x 2 (300 x 1)	n/a
High Current Watts	37.5 x 2 (75 x 1)	75 x 2 (150 x 1)	150 x 2 (300 x 1)	150 x 2 (300 x 1)
	<i>REFERENCE 500</i>			
High Power Watts	125 x 2 (250 x 1)	250 x 2 (500 x 1)	250 x 2 (500 x 1)	n/a
High Current Watts	62.5 x 2 (125 x 1)	125 x 2 (250 x 1)	250 x 2 (500 x 1)	250 x 2 (500 x 1)

THD	<0.1%
Signal to Noise	>100 dB
Frequency Response	20 Hz to 20 kHz ± 0.5 dB
Stereo Separation	>90 dB
Damping	>200
Input Sensitivity	100 mV - 2.5 V
Input Impedance	12K ohms
LSE.Q (REFERENCE500)	0.7 - 2.8 Q (0 to +9 dB) adjustment from 30 to 60 Hz

Dimensions (W x D x H)

REFERENCE200	6.25" x 9.5" x 2.25"
REFERENCE300	8.5" x 9.5" x 2.25"
REFERENCE500	12" x 9.5" x 2.25"